

LOCOLOC[®]

Cutting Tools



HC-20

Handheld Hydraulic Cutter

Operator's Manual



CONTENT

Title	Page
Specifications	1
General Information Guide	2
Troubleshooting Guide	5
Operating Instructions	7
Parts Diagram	8
Parts List	9
Warranty	10

SPECIFICATIONS

FEATURES

- Lightweight and Portable
- Works in Any Position
- 180° Rotational Head

SPECIFICATIONS

Output:	4.4 Ton
Weight:	6 Lbs.
Size:	14"L
Jaw Opening:	.75"

CAPACITIES

Wire Ropes:	20 mm, 3/4"
Soft Steel Bolts:	17 mm, 11/16"
Chain:	DO NOT CUT

GENERAL INFORMATION GUIDE

The following steps are guidelines for safe operation of the cutters. Please take the time to review them as these are helpful hints that have been accumulated over the years.

1. Stay within the maximum cutting limits of each tool as listed.
2. Try to keep the cutter head clean. When cleaning, use a spray lubricant to avoid a buildup of dirt and sand which damage the cutter head.
3. Stop pumping when the blade reaches the extreme end of its advance. If the material being cut (usually wire rope or soft cables) seems to be cut but does not break free of the tool, this indicates that the blade is jammed on a small piece of cable. Refer to “troubleshooting” to free the blade.
4. All tools require proper care. Occasional cleaning and degreasing in solvent, and sharpening blade and cutter head, will keep these tools operating without problems.
5. The most common problem encountered is blade breakage. **Ninety-nine percent of all breakage occurs because the cutter head is not securely latched before cutting.** If the latch is not secured, the blade will push open the cutter head and damage both the body head and blade. This causes the outside ear to the blade to break on an angle. In some cases, the whole cutter head may crack in half. Cutting material that is not specified may also cause blade damage. In time, these blades will fatigue and crack and must be replaced.

GENERAL INFORMATION GUIDE

6. There may be a residue of oil present on new tools when they are removed from the original shipping container. This is to protect the tool from corrosion during shipment and storage, and should not be considered defective. The tool can be cleaned with a spray degreaser or soapy water.
7. If tool is jammed, avoid beating directly on the tool with a hammer, especially avoid flattening the piston cylinder. Use a hammer in conjunction with a block of wood or soft material to free the blade.
8. All tools can be reconditioned and overhauled. Call factory and obtain an RGA # for returning tools.
9. If the cutters are used under water, wash them down and lubricate after each use. This whole operation takes less than five minutes. It may be helpful to paint new tools with a light color, corrosion resistant paint.
10. Always return tools to their carrying bag to protect them from sand and dirt.
11. Always carry a spare blade (Part No. 20-07), preferably attached to the carrying case.
12. When cutting, keep area clear of spectators as hardened metals may fly apart when severed.

TROUBLESHOOTING GUIDE

13. Always cut the material at a 90 degree angle to the blade. Any other angle may cause the blade and head shear to fracture. See illustration below.

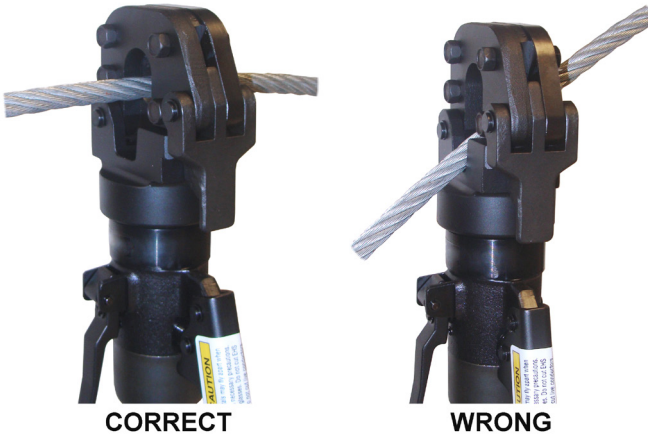

BLADE SHARPENING INSTRUCTIONS

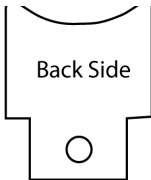

- 1) Set Blade on Flat Surface with Beveled Edge Facing Down.
- 2) Use a Sharpening Stone to Remove All Burrs From Back Surface.

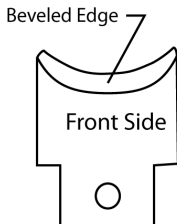
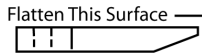

- 3) Use a High Speed Dremel Type Tool to Flatten Top Edge of Blade.
* Do Not Sharpen Like a Knife Edge!!

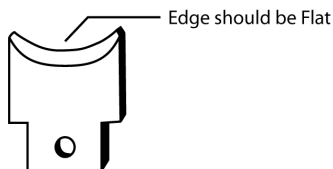

TROUBLESHOOTING GUIDE

1. **Problem:** Small wire strands or pieces of cable or debris get jammed between the cutter head and blade, not allowing the blade to retract.

Solution:

A) Hold release lever down while tapping on the ram with a block of wood and a hammer. If this does not work or tool continues to hang up, proceed to step "B".

B) Remove blade screw and release the ram. Then disassemble cutter head and remove burrs from both blade and head shear, using a flat grinding stone on the rolled edge. **Do not sharpen like a knife - leave cutting edge flat!** See illustration on page 8

2. **Problem:** Blade is advanced under pressure with no load and the release lever seems to be stuck.

Solution:

A) Use both hands to depress release trigger using body weight and the ground or other strong surface for support. If this does not work, proceed to step "B".

B) Lay tool flat on the ground or other strong surface and hit release lever with a block of wood and a hammer to release pressure.

**USE WOOD OR
SOFT MATERIAL
TO AVOID CHIPPING**

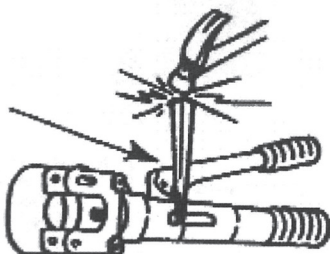

TROUBLESHOOTING GUIDE

3. Problem: Tool will not advance when handle is pumped.

Solution:

A) Remove body handle and check oil reservoir for proper fluid level. The oil should be to the top of the reservoir when the cap is removed. Be sure the tool is fully retracted before removing cap.

B) After storing for a long period of time, or occasionally when the tool is new, a check ball may be stuck not allowing it to advance. Invert the tool and rap the cutter head sharply on the ground. Do this several times, then pump handle to advance the blade.

OPERATING INSTRUCTIONS

1. Before cutting, make sure the material being cut is within the proper cutting capacity of the tool being used.
2. Open cutter head by lifting latch or removing lock pin, depending on the model being used.
3. Insert material between cutter head and blade and secure latch. It is important that you check the latch for proper engagement before continuing with the cut. Failure to secure the latch can result in severe tool damage and personal injury.
4. Align the material 90 degree angle to the blade. This will ensure a proper cut with minimal distortion. If the material is cut at any other angle, severe blade damage may occur. Refer to diagram on page 6 for proper alignment.
5. Proceed by pumping handle to advance blade. Once blade has made contact with the material, check alignment once again for proper angle. Continue to pump handle and cut material.
6. Once the cut is made, the release lever on the side of the tool body can be depressed to retract the blade.
7. These cutters do not have a by-pass cartridge like our compression tools, so they should be released once the cut is made and not continued to be advanced. If the tool is advanced under pressure with no load, it is difficult to release the blade. Refer to the troubleshooting on page 7 if this condition occurs.
8. Always wear eye protection and any other specified safety equipment when cutting. Be sure surrounding area is clear, as hardened metals may fly apart when severed.
9. **Do not use to cut EHS Guy Wire or Bridge Strand. Contact Loos & Co., Inc. for these cutters.**

PARTS DIAGRAM

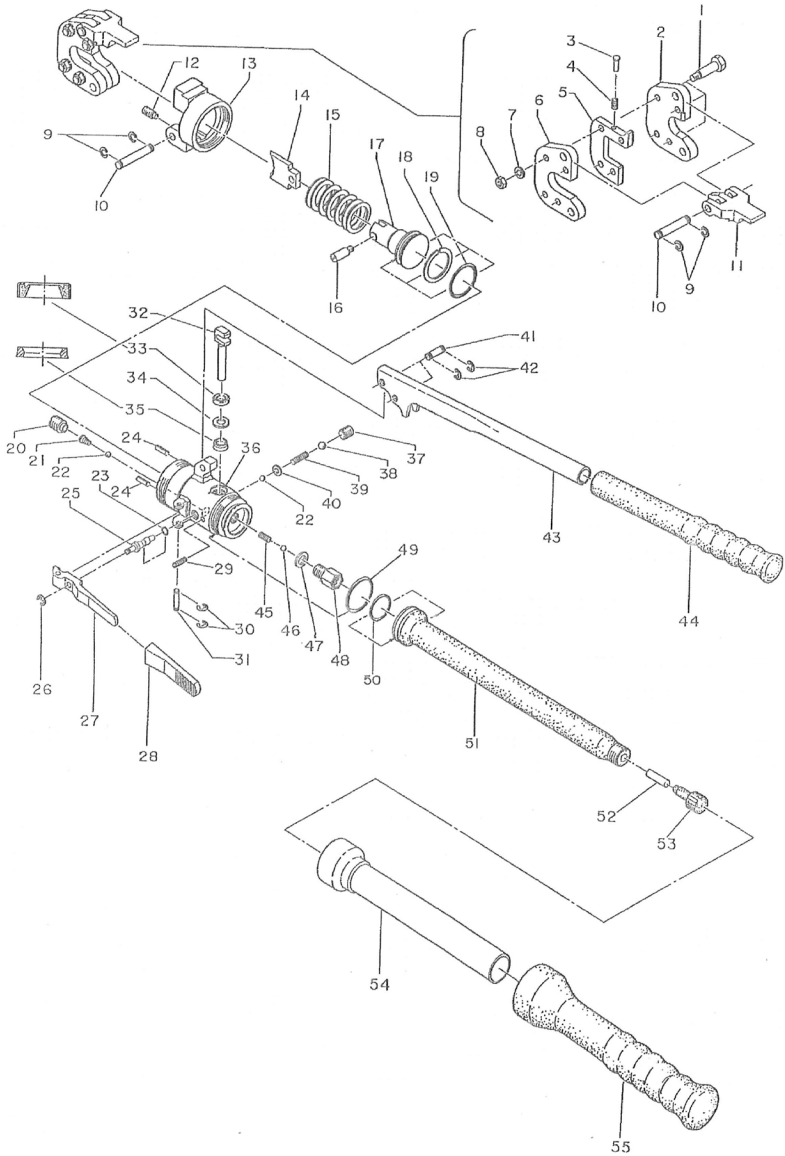

PARTS LIST

NO.	DESCRIPTION	CODE	QTY.	NO.	DESCRIPTION	CODE	QTY.
1	Shoulder Bolt	16-03B	4	49	S-36 O-Ring	85-51	1
2	Head Shear	20-02	1	50	P-26 O-Ring	16-55	1
3	Slide Pin	20-71	1	51	Oil Reservoir (4)	20A-03	1
4	Spring (144)	85-37	1	52	Magnet	ROB-25	1
5	Spacer	20-70	1	53	Reservoir Cap	410-55	1
6	Main Head	20-04	1	54	Body Handle	16-63	1
7	M6 Lock Washer	16-02	4	55	Body Handle Grip	20-11	1
8	M6 Hex. Nut	16-01	4				
9	CE-8 Snap Ring	16-09	4				
10	Pin (46)	16-10	2				
11	Latch	16-11	1				
12	M5 X 10 Screw (D.P.)	55A-11	1				
13	Body Head	20A-01	1				
14	Blade	20-07	1				
15	Spring (75)	16-17	1				
16	Blade Screw	16-19	1				
17	Ram	16-21	1				
18	P-29 Back-Up Ring (B.C.)	16-22	1				
19	P-29 O-Ring	16-23	1				
20	Valve Screw (3)	16-24	1				
21	Spring (2)	16-25	1				
22	7/32" Ball	16-26	2				
23	P-3 O-Ring	16-36	1				
24	2.5 X 10 Dowel Pin (D)	40A-03	2				
25	Release Valve Stem	16-35	1				
26	E-3.2 Snap Ring	16-33	1				
27	Release Lever	20-08	1				
28	Release Lever Insulation	20-09	1				
29	Spring (77)	16-37	1				
30	E-2.5 Snap Ring	16-28	2				
31	Pin (26)	16-27	1				
32	Pump Piston	16-47	1				
33	VC8 Oil Seal	40A-05	1				
34	P-8 Back-Up Ring (B.C.)	85-33	1				
35	PS-8 Pent Seal	16-44	1				
36	Body	20A-02	1				
37	M10 X 10 Screw (F.P.)	16-41	1				
38	9/32" Ball	16-40	1				
39	Spring (76)	16-39	1				
40	M3 Flat Washer	16-38	1				
41	Pin (47)	16-29	2				
42	CE-6 Snap Ring	16-30	4				
43	Pump Handle	16-31	1				
44	Pump Handle Grip	20-10	1				
45	Spring (4)	16-48	1				
46	3/16" Ball	16-49	1				
47	Copper Gasket (6)	16-50	1				
48	Suction Valve Screw Ass'y	16-51	1				

WARRANTY

Huskie Tools products carry a warranty that makes us a leader in the tool industry. No other manufacturer dares to back its tools as we do.

All Huskie REC-SERIES battery-operated products carry a 5-year warranty. The ECO-SERIES battery-operated products carry a 1-year warranty. The IL-ND battery-operated products carry a 3-year warranty. The BP-70E, BP-70EI, BP-70MH, and BP-80 batteries carry a 5-year or 1,000 recharge cycles warranty from the date stamped on the battery.

PRODUCT WARRANTY

REC-Series battery-operated products	5 Years
ECO-Series battery-operated products*	1 Year
IL-ND battery-operated products	3 Years
Batteries (BP-70E, BP-70EI**, BP-70MH, BP-80)	5 Years
Chargers (CH-35R, CH-70DCH, CH-90, CH-86)	5 Years

*Please call the factory with warranty questions.

**The BP-70EI is no longer available. The LED indicator on the BP-70EI carries a 1-year warranty from purchase date.

The warranty does not cover any damages incurred from a Huskie tool including damages to property, bodily injuries, and lost wages resulting from such injuries. This warranty solely covers the repair or replacement of tools supplied by Huskie. These remedies are exclusive, and the total liability of Huskie Tools, Inc. whether based on contract, warranty, negligence, indemnification, strict liability or otherwise, shall not exceed the purchase price of the tool. In no event shall Huskie Tools, Inc. be liable for consequential, incidental or special damages.

HUSKIE TOOLS, INC. MAKES NO OTHER WARRANTIES OF ANY KIND, EXPRESSED OR IMPLIED, AND ALL IMPLIED WARRANTIES INCLUDING ANY WARRANTY OF MERCHANTABILITY AND FITNESS FOR A PARTICULAR PURPOSE ARE DISCLAIMED.

WARRANTY (CONT.)

Huskie reserves the right to determine all warranty claims. Huskie will not warranty tools containing parts or batteries not originally supplied by Huskie. Failure due to misuse, improper maintenance, misapplication, not following instructions or warnings, abuse or repairs attempted by anyone other than Huskie Tools, Inc. or an authorized service center renders this warranty null and void.

Repair and Warranty Claims

All claims must be sent to Huskie for inspection and authorization. A Return Goods Authorization (RGA) is required before shipping tools to Huskie. Secure the authorization by telephoning or writing to Huskie's main office with details of the claim. Non-warranty repairs are handled using the same procedure. Repairs exceeding 50 percent of the cost of a new tool will be advised before repairs are made.

Payment Terms

Upon credit approval, Huskie's standard payment terms are net-30 days. Visa, Mastercard, Discover, and American Express are also accepted.

Freight

All Huskie Tools are FOB, Glendale Heights, Illinois. Goods will be shipped pre-paid and added, unless otherwise specified. Freight shipments over \$17,000 are pre-paid.

Quotations

Special quantity quotations should be phoned in to discuss the scope of your tool requests.

WARRANTY (CONT.)

Complete Support Services

Our customers have direct access to us for training, service, and problem solving. As specialists in tools, we maintain a trained repair staff and a large stock of parts. This contrasts with many tool suppliers who carry tools as a sideline without offering support services. Here are some reasons why our customers love to do business with us:

- Quick delivery
- We maintain inventory in our headquarters
- Training and troubleshooting services
- Fast repair service
- Design and engineering service for special tools

HOW TO GET SERVICE UNDER THE TERMS OF THE LIMITED WARRANTY

Return your product directly to Huskie Tools, Inc. as our representative network is not prepared to service the product under the terms of this warranty.

1. Write, call, or fax Huskie stating the tool's purchase date and problem. You will be given an RGA # to assure that your merchandise will be properly handled upon its receipt.
2. CAUTION: Make sure the product is packaged adequately so as to prevent damage or loss during transit. The shipment must be prepaid and we recommend that it be insured. A cover letter indicating the reason for the return should be included in order to facilitate repairs.
3. To fill out an RGA online, go to HuskieTools.com and click on "Repairs."



198 N. Brandon Drive, Glendale Heights, IL 60139

Phone: (800) 860-6170 Fax: (800) 345-3767

HuskieTools.com





901 Industrial Blvd • Naples, FL 34104
Tel: (239) 643-LOOS • Fax (239) 643-4558
E-mail: info@loosnaples.com • Website: www.loosnaples.com